

FLUID CONTROL SYSTEM N° 226-FCS

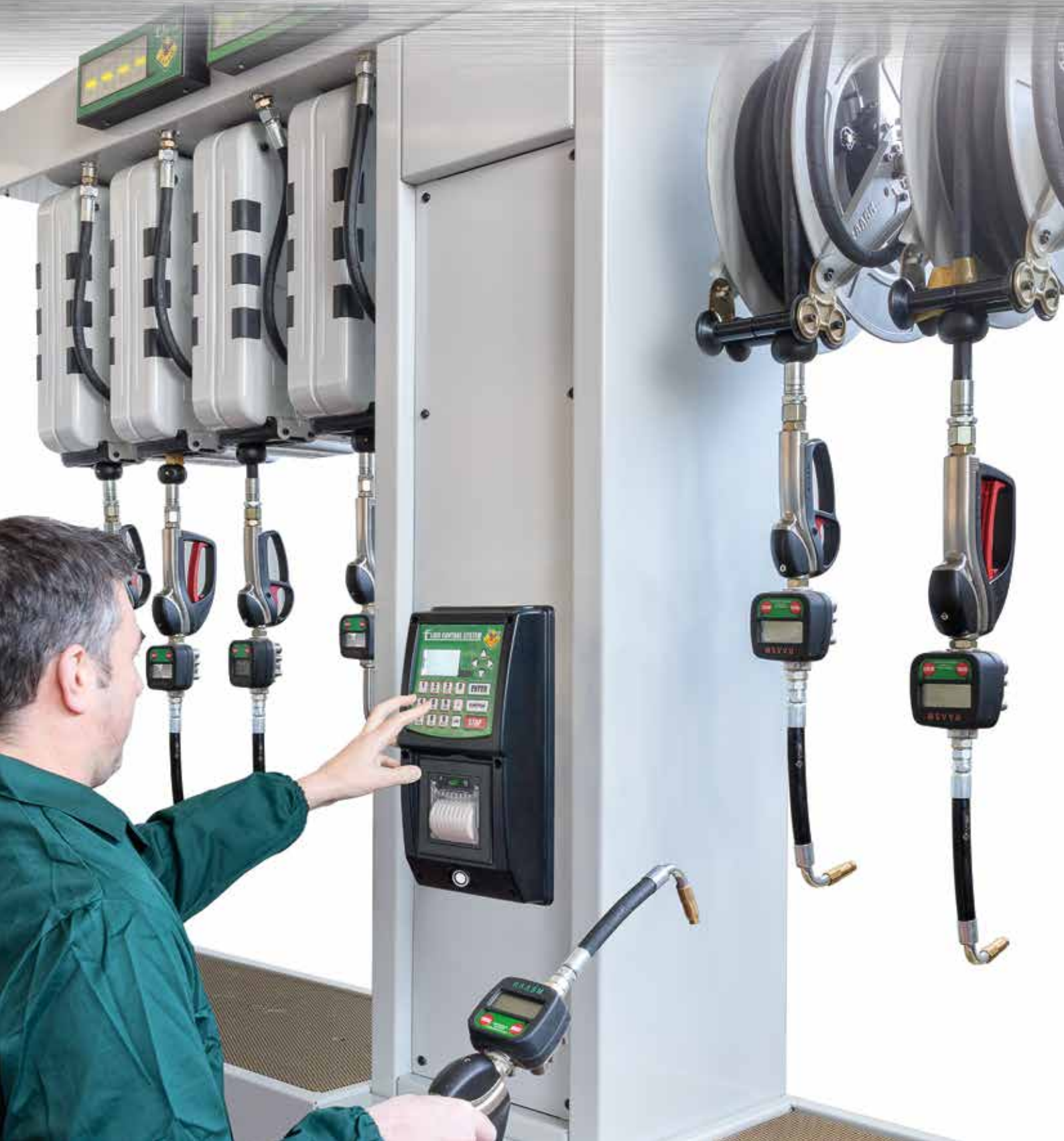

FLUID CONTROL SYSTEM

**ADVANCED FLUID
MANAGEMENT SOLUTIONS**





**ADVANCED FLUID
MANAGEMENT SOLUTIONS**

*the human side
of Quality*



founded in 1975





**ADVANCED FLUID
MANAGEMENT SOLUTIONS**

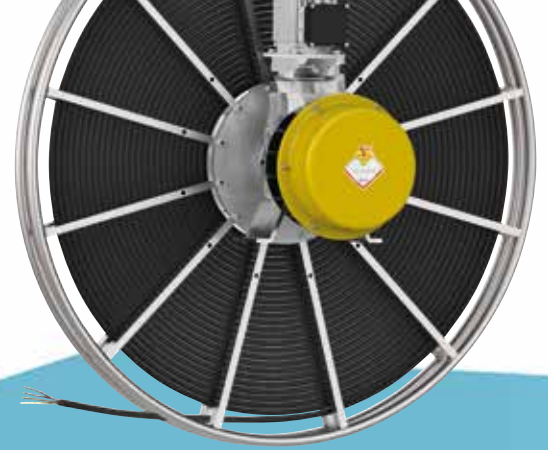



2020



2014

2015

2016

2018

More than **5000** products available
for your business



1983

1979

1978

1975



**ADVANCED FLUID
MANAGEMENT SOLUTIONS**

VISION

DESIGN

TECHNOLOGY

QUALITY

EFFICIENCY

ASSISTANCE

ENVIRONMENT

PACKAGING

SHARING

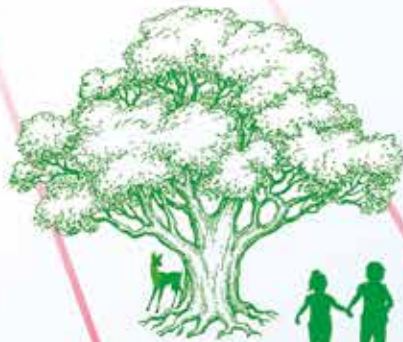

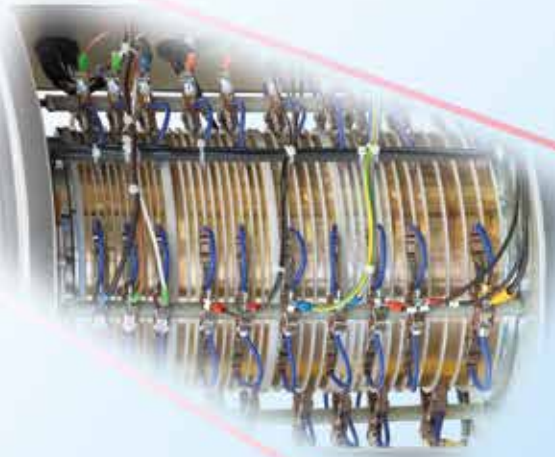



FCS - Fluid Control System



The FCS is an integrated system **for managing and controlling the dispensing** of fluids in maintenance facilities. Highly versatile and intuitive, it **allows customised configurations** in order to fully adapt to the customer's needs.

RAASM offers two versions to satisfy every specific need:

BASIC

 **FULL OPTIONAL**

MAIN CHARACTERISTICS

- Automatic control of fluid inventories.
- OCU display with simple and intuitive menu.
- Summary ticket for each fluid dispense (optional).
- Ability to connect to PC and to create an internal Network.
- Dispensing authorised by access code and memorization of every single operation.
- Protection cover which ensures the IP55 protection degree (model without printer).
- Electronic board with protection from overload and short circuit.

FLUID CONTROL SYSTEM CAN MANAGE:

DATABASE

The internal memory of the OCU allows the recording of up to a maximum of 4000 operations. When connected to a PC, dedicated software supplied with the FCS enables data management and customization of the system, as well as sending the stored data.

TANKS

The FCS can manage up to a maximum of 999 tanks, associated with the type of fluid contained. The quantity of fluid inside each tank is constantly calculated by the system. Also, special reserve and delivery blocking alarms, prevent going below a minimum level fixed by the administrator.

FLUIDS

The FCS can manage all the following automotive fluids: lubricating and hydraulic oils, antifreeze, diesel, AdBlue®. Each fluid is distinguished by the complete name and an abbreviation (6-characters). The quantities dispensed are counted with the unit of measure chosen by the administrator: Liters, Gallons, Quarts, Pint.

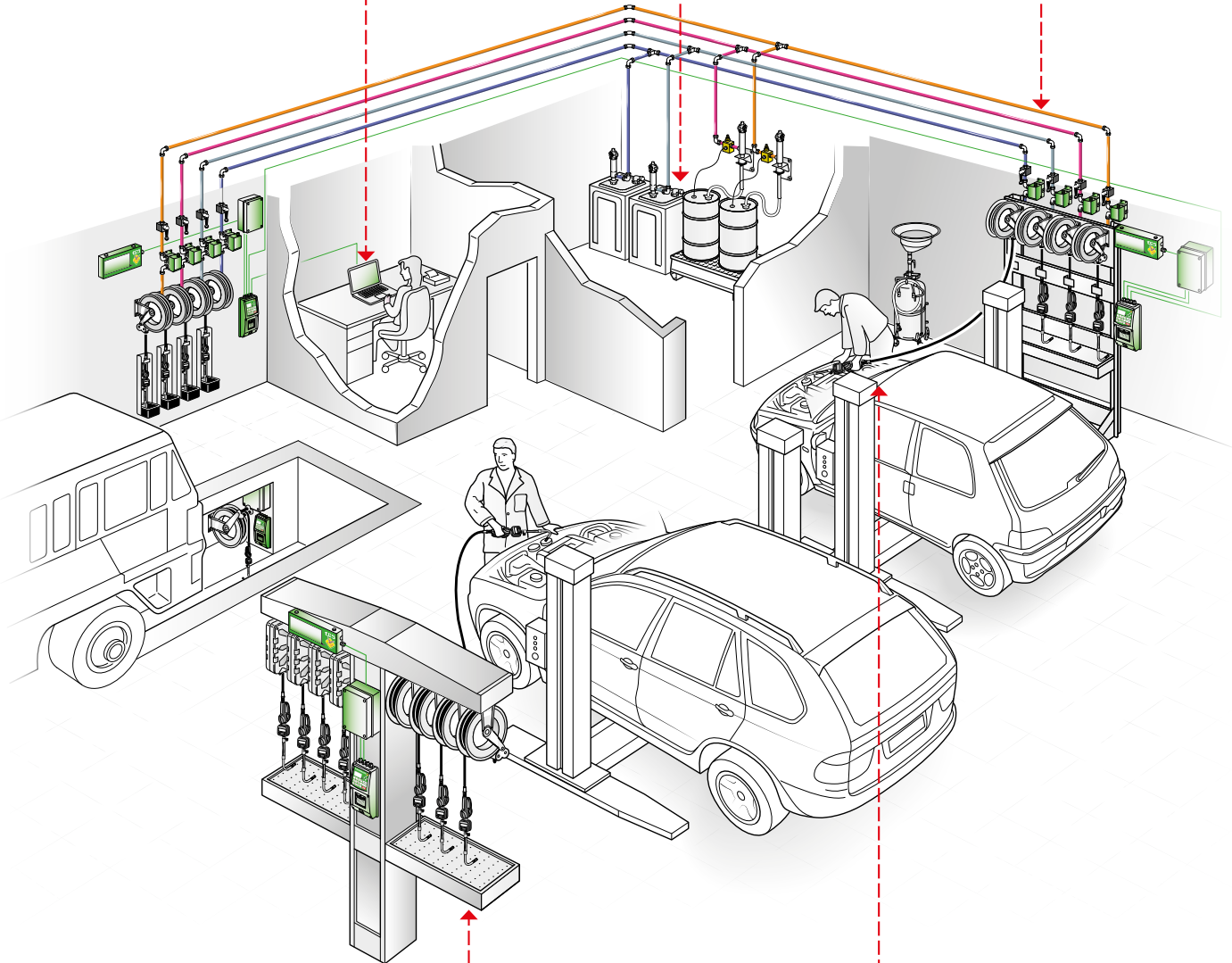

DISPENSERS (OUTLETS)

The FCS manages up to a maximum of 1188 dispensing points. Each Operator Control Unit (OCU) can manage a maximum of 12 outlets, 6 of which are able to work at the same time. The date and time, operator's name, order number and vehicle number-plate, type of fluid and quantity dispensed are recorded for each dispensing operation. All these details can be printed on tickets (optional).

OPERATORS

The FCS can be used by a maximum of 1000 authorized operators, who can access the system by entering a numerical password, or by using the "iButton®" key (only in the Full Optional version). All the operations carried out are stored in the system's memory.



FCS - SOFTWARE

STANDARD VERSION

The FCS software is easy to use.
The system is simple to configure
for accurately managing tanks, operators,
dispensers, fluids and more.
The FCS software also provides tools
for analyzing your fluids consumption.

NETWORK VERSION

Installed with the standard version only
on request, allows to create a PC Network
connected with FCS.

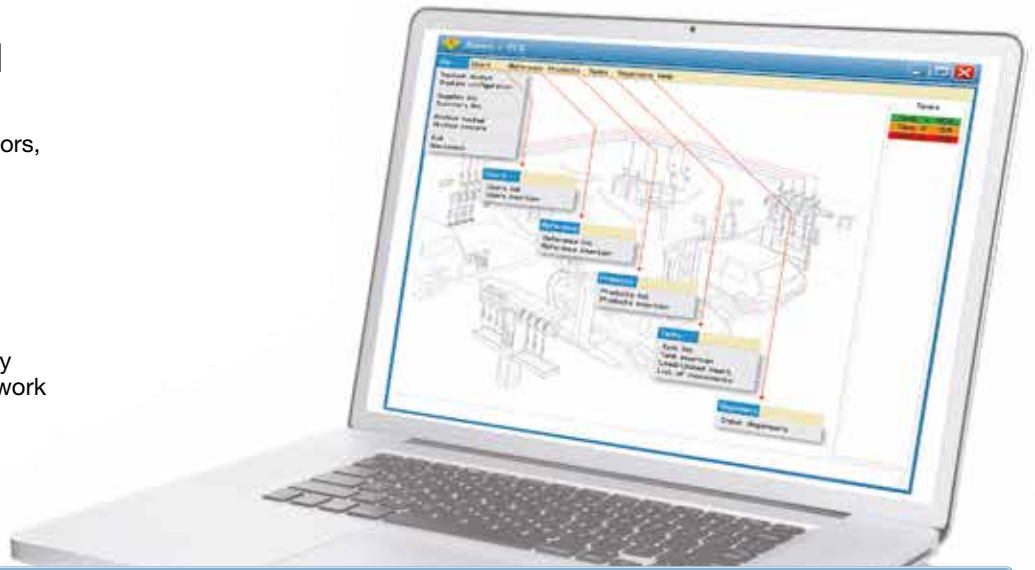

File

- System status
- System configuration
- Supplies list
- Summary list
- Archive backup
- Archive restore
- Exit
- Disconnect

Users

- Users list
- Users insertion

Reference

- Reference list
- Reference insertion

Products

- Products list
- Products insertion

Tanks

- Tank list
- Tank insertion
- Load/Unload insert
- List of movements

Dispensers

- Enter dispensers

Tanks status

| | |
|--------|-----|
| Tank 1 | 90% |
| Tank 2 | 15% |
| Tank 3 | 5% |

OPERATOR CONTROL UNIT: MENU



The Operator Control Unit allows the administrator to access to a detailed menu where personalized configurations can be entered and the entire system managed. If the OCU is connected with a computer most of the operations shown above can be managed through the FCS software (see page aside).

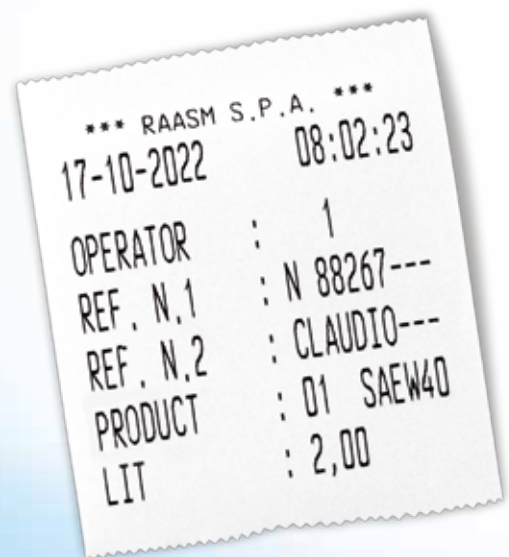

Every delivery can be summarized by a printed ticket (optional) which shows the most important information recorded by the system.



FCS - BASIC

If you need a simplified system, with all the FCS main characteristics but only with the basic control equipments, this is your favorite version. This system, easily intuitive and versatile, differs from the Full Optional version because it doesn't have the "iButton®", the physical maximum level gauge for waste oil, the physical minimum level gauge for new fluids and the pneumatic solenoid valve in each pump. Instead, the connection with a general pneumatic solenoid valve for the air pumps feeding is ready.

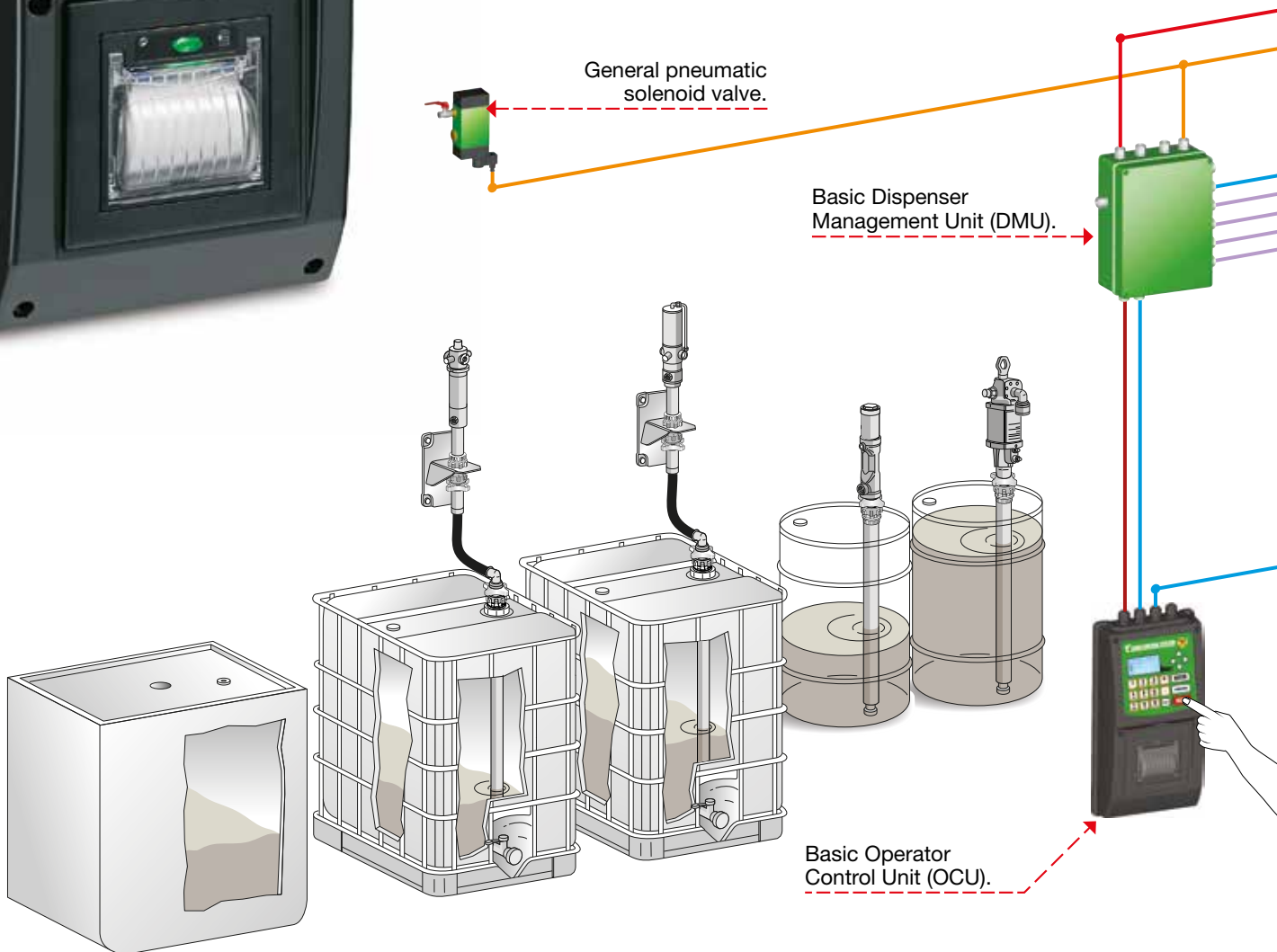

| CABLE | DESCRIPTION | LENGTH |
|-------|--|------------|
| | Each DMU must be powered by 115 V (AC) / 230V (AC), 50 / 60 Hz electrical network and provides 24V (DC) power to the other components of the FCS system. | max 100 m |
| | Cable for connecting general air supply solenoid valve to DMU | max 1000 m |
| | Data cable RS485 for connection between OCU, DMU1, DMU2, up to DMU3. Data cable RS485 for connection between the main PC and the last OCU of the network. | max 1000 m |
| | Cable for connecting DMU with nr.4 PDV or nr.4 PSV | max 30 m |
| | Power cable OCU 24 V (DC) | max 100 m |

The basic version of the OCU may be provided or not with printer for tickets, in order to the customer's needs; also the DMU is available with a simplified version. This basic version can be customized according to specific work needs by adding the components to the FCS Catalogue.

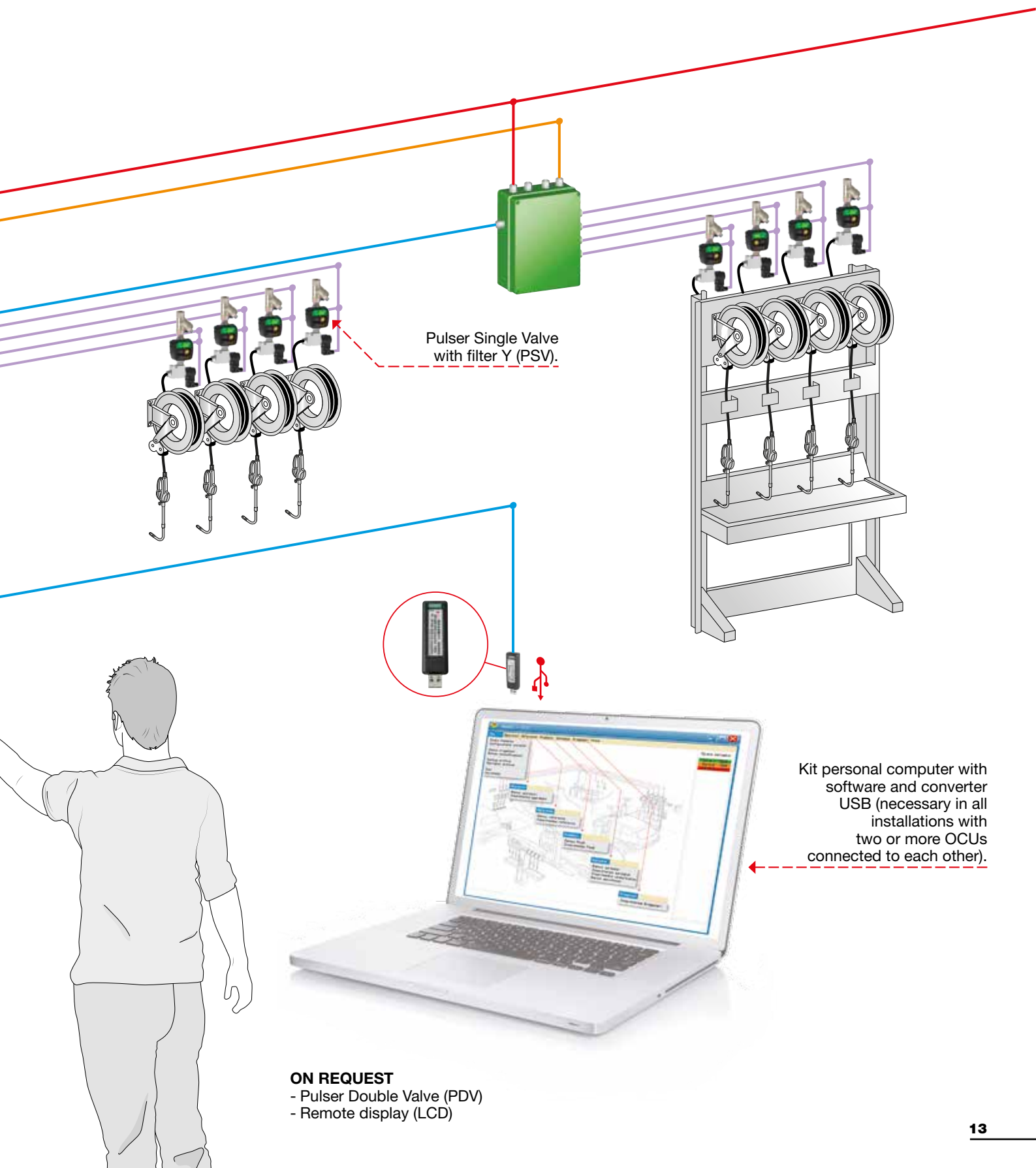



FCS - FULL OPTIONAL



It is the full version of the Fluid Control System, with available all the control equipments and the system interaction tools. You can choose this package for its completeness and functionality in each working phase. Recommended the connection with only one general pneumatic solenoid valve for the simultaneous supply of the pumps.

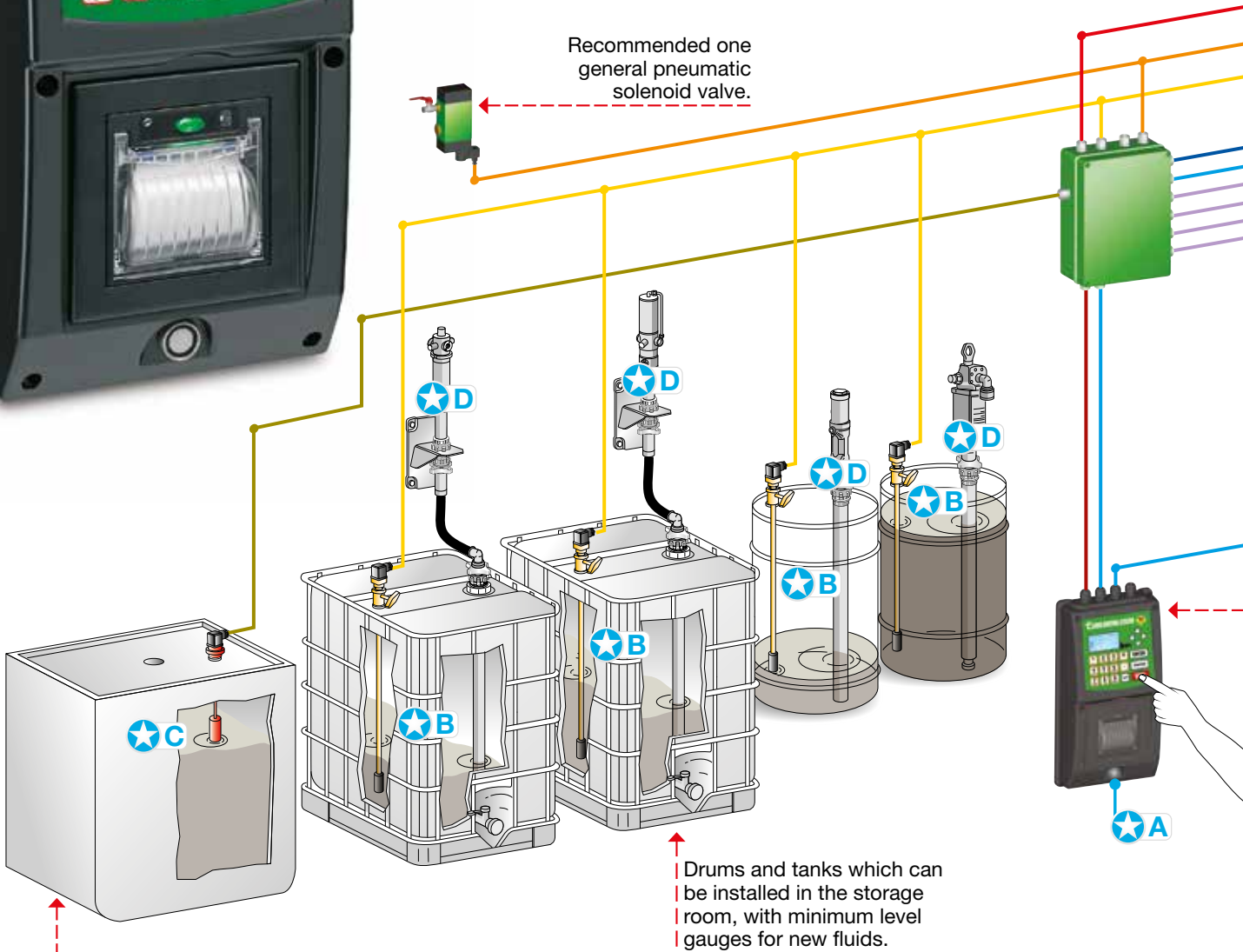

| CABLE | DESCRIPTION | LENGTH |
|-------|--|------------|
| | Each DMU must be powered by 115 V (AC) / 230V (AC), 50 / 60 Hz electrical network and provides 24 V (DC) power to the other components of the FCS system. | max 100 m |
| | Cable for connecting main air supply solenoid valve to DMU | max 1000 m |
| | Cable for connecting minimum level indicator to DMU | max 1000 m |
| | Data cable RS485 for connection between DMU, LCD1 up to LCD2. | max 30 m |
| | Data cable RS485 for connection between OCU, DMU1, DMU2, up to DMU3. Data cable RS485 for connection between the main PC and the last OCU of the network. | max 1000 m |
| | Cable for connecting maximum waste oil level indicator to DMU | max 1000 m |
| | Cable for connecting DMU with nr.4 PDV or nr.4 PSV | max 30 m |
| | Power cable OCU 24 V (DC) | max 100 m |

Specifically (compared to the basic version):

- ★A The “iButton®” device is available, the OCU may or may not be equipped with a ticket printer.
- ★B The connectors for the fresh oil minimum level check are available.
- ★C The connector for the waste oil maximum level check is available.
- ★D The air feeding check for each pump is available.

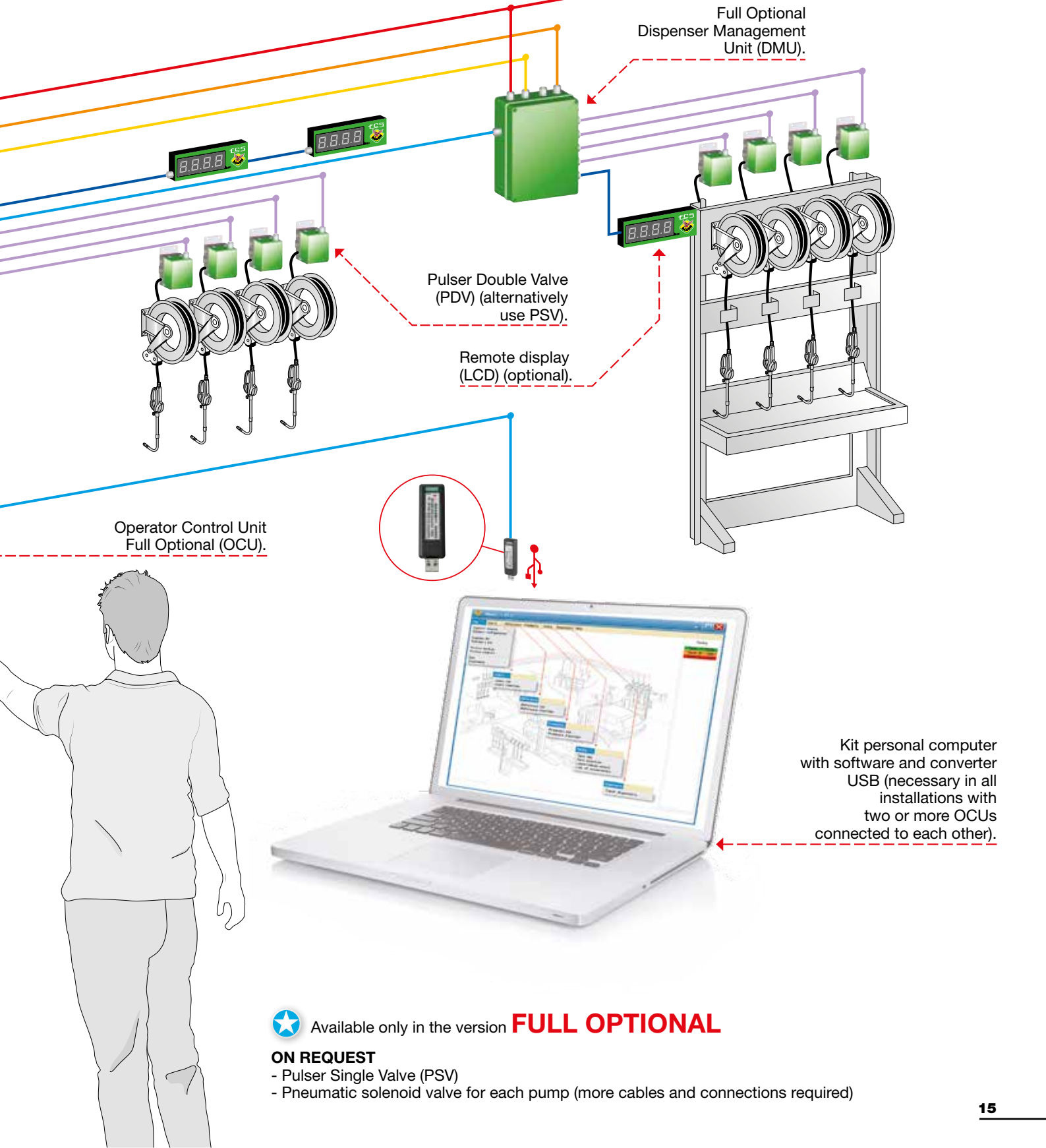

★ Available only in the version **FULL OPTIONAL**

ON REQUEST

- Pulser Single Valve (PSV)
- Pneumatic solenoid valve for each pump (more cables and connections required)



FCS COMPONENTS



P/N 39599 OPERATOR CONTROL UNIT FULL OPTIONAL (OCU)

The OCU is installed near the dispensing points and allows operators to communicate with the system by means of the special membrane keypad and large display. Provided with iButton®. A printer for tickets is located under the keypad.

P/N 39598 OPERATOR CONTROL UNIT FULL OPTIONAL (OCU)

Model as above but without printer for tickets.

P/N 39591 OPERATOR CONTROL UNIT BASIC (OCU)

OCU designed for the basic version without "iButton®" but with printer for tickets.

P/N 39590 OPERATOR CONTROL UNIT BASIC (OCU)

OCU designed for the basic version both without "iButton®" and printer for tickets.

Important: for operation, each OCU must be connected at least to a DMU.

System functionality:

- Access to the system by means of PIN code or "iButton®" device (where provided)
- Customizable ticket printout at the end of each dispensing operation (version with printer)
- Up to 1000 authorized operators
- Memory holds up to 4000 operations
- Possibility of free dispensing or preset amount
- Individual calibration of each single dispenser
- Large graphic display with intuitive and easy to scroll through menu
- Possibility of connecting the system to a PC (required in all installations with two or more OCU connected to each other)
- Up to 6 simultaneous deliveries (when connected with 3 DMUs)
- It is possible to manage up to 12 dispensers/fluids/tanks when using 3 DMUs
- Available in many languages: Italian, Spanish, French, Portuguese, English, German, Polish, Hungarian, Czech, Russian, Latvian, Turkish (other languages on request)



P/N 39605 DISPENSER MANAGEMENT UNIT (DMU)

As well as sending commands to all the components of the system, the Dispenser Management Unit (DMU) ensures the low voltage (24 V DC) power supply. It contains all the electrical connections for the system. Each DMU directly controls up to 4 dispensers.

DMU characteristics:

- Powered by 115 V AC - 230 V AC 50/60 Hz, it supplies the 24 V DC feed to all the components of the system
- Can control up to 4 dispensers which are each connected to a pulser-valve unit (PDV or PSV)
- Enables the simultaneous use of 2 dispensers per DMU unit
- Max. distance between DMU and pulser-valve: 30 m
- Suitable to be connected with 4 oil minimum level gauges for new fluids and 1 waste oil maximum level gauge
- 4 pneumatic solenoid valves (one per pump) can be connected to keep the pump under pressure only during operations
- Recommended one general pneumatic solenoid valve for air supply of all the pumps
- 2 Remote display may be connected with the DMU

P/N 39595 DISPENSER MANAGEMENT UNIT BASIC (DMU)

This is the DMU version to use with a basic system without the physical maximum level gauge for waste oil, the physical minimum level gauge in each drum for new fluids and the pneumatic solenoid valve in each pump. Instead, the connection with a general pneumatic solenoid valve for the air pumps feeding is ready.



P/N 39630 PULSER DOUBLE VALVE (PDV) *

The PDV is installed along the pipe that takes the fluid from the pump to the dispensing points. It closes the supply line, acting as a valve that opens when receiving consent from the DMU to which it is connected. It also measures the product flowing through the pipe, immediately sending the data to the DMU which feeds it with 24 V DC. The double valve offers greater precision in measuring the dispensed fluid, by reducing the flow before reaching the preset quantity. Inlet and outlet connections G 1/2" (f).
Max working pressure 70 bar.



COMPONENTI FCS

P/N 39620 PULSER SINGLE VALVE (PSV) FOR OIL 1/2" *

The Pulsar Single Valve version for oil with G 1/2" (f) connections.
Max working pressure 70 bar.

P/N 39623 PULSER SINGLE VALVE (PSV) FOR OIL 3/4" *

The Pulsar Single Valve version for oil with G 3/4" (f) connections.
Max working pressure 70 bar.

P/N 39631 PULSER SINGLE VALVE (PSV) FOR OIL 1" *

The Pulsar Single Valve version for oil with G 1" (f) connections.
Max working pressure 70 bar.

P/N 39621 PULSER SINGLE VALVE (PSV) FOR ANTIFREEZE 1/2" *

The Pulsar Single Valve version for antifreeze and windshield washer fluid with G 1/2" (f) connections. Max working pressure 70 bar.

P/N 39624 PULSER SINGLE VALVE (PSV) FOR DIESEL 3/4" *

The Pulsar Single Valve version for diesel with G 3/4" (f) connections.
Max working pressure 30 bar.

P/N 39633 PULSER SINGLE VALVE (PSV) FOR DIESEL 1" *

The Pulsar Single Valve version for diesel with G 1" (f) connections.
Max working pressure 30 bar.

- All the PSVs are fed by the DMU 24 V DC
- Use a filter upstream of PSV



P/N 39625 PULSER SINGLE VALVE (PSV) FOR OIL 1/2" WITH Y FILTER *

The Pulsar Single Valve version for oil with G 1/2" (f) connections.
Max working pressure 70 bar.

P/N 39627 PULSER SINGLE VALVE (PSV) FOR OIL 3/4" WITH Y FILTER *

The Pulsar Single Valve version for oil with G 3/4" (f) connections.
Max working pressure 70 bar.

P/N 39629 PULSER SINGLE VALVE (PSV) FOR OIL 1" WITH Y FILTER Y *

The Pulsar Single Valve version for oil with G 1" (f) connections.
Max working pressure 70 bar.

P/N 39626 PULSER SINGLE VALVE (PSV) FOR ANTIFREEZE 1/2" WITH Y FILTER *

The Pulsar Single Valve version for antifreeze and windshield washer fluid with G 1/2" (f) connections. Max working pressure 70 bar.

P/N 39628 PULSER SINGLE VALVE (PSV) FOR DIESEL 3/4" WITH Y FILTER *

The Pulsar Single Valve version for diesel with G 3/4" (f) connections.
Max working pressure 30 bar.

P/N 39634 PULSER SINGLE VALVE (PSV) FOR DIESEL 1" WITH Y FILTER Y *

The Pulsar Single Valve version for diesel with G 1" (f) connections.
Max working pressure 30 bar.

- All the PSVs are fed by the DMU 24 V DC
- Y filter as standard



P/N 39515 SOLENOID VALVE FOR PSV 1/2"

P/N 39517 SOLENOID VALVE FOR PSV 3/4"

P/N 39516 SOLENOID VALVE FOR PSV 1"

* not type-approved for public use



COMPONENTI FCS



P/N 39622 AISI 304 STAINLESS STEEL PULSER SINGLE VALVE (PSV) FOR ADBLUE® 1/2" *

AISI 304 stainless steel Pulser Single Valve version for AdBlue® with G 1/2" (f) connections. Max working pressure 16 bar.



P/N 39632 AISI 304 STAINLESS STEEL PULSER SINGLE VALVE (PSV) FOR ADBLUE® 1/2" WITH Y FILTER *

AISI 304 stainless steel Pulser Single Valve version for AdBlue® with G 1/2" (f) connections. Max working pressure 16 bar.



P/N 39518 AISI 304 STAINLESS STEEL SOLENOID VALVE FOR PSV 1/2"



P/N 39640 REMOTE DISPLAY (LCD)

The remote display allows the dispensed quantities to be viewed from a distance. It is possible to connect 2 remote displays for each DMU.

- Fed by DMU 24 V DC



FCS COMPONENTS

P/N 39680 KIT PERSONAL COMPUTER (KIT MAIN PC)

The PC Kit enables a personal computer to centralize and manage the system. It comprises a USB signal converter to connect the OCU to the PC and a standard software on USB flash drive to be installed on the main PC in the workshop. The software has been designed to manage all necessary operations to control dispensing, including but not limited to: system configuration, operator setup, and checking inventory. It is essential in all installations with two or more OCUs connected together.

It manages:

- Max. 1000 operators
- Max. 999 tanks
- Max. 255 fluids
- Max. 5000 reference numbers (or order numbers)
- Can set unit of measure to liters, gallons, quarts or pints (liters set as default)
- Tank block level
- Tank alarm level
- Max. 1188 controlled outlets
- Windows compatible software
- Data can be exported as an xls, xlsx, txt, csv or ods file for compatibility with other management software
- Can dispense directly from your PC
- Can preset multiple dispensing quantities, which are identified by a "Ref number"
- Displays remaining stock in real-time for every tank
- List of tank loading/unloading movements



It is possible to connect the FCS software with specific management software by contacting the RAASM technical office which will verify the compatibility of the request.

P/N 39681 SOFTWARE NETWORK PER PC CLIENT

(to integrate only on request with P/N 39680)

It consists of a USB flash drive containing the network software to be installed on client PCs of the offices to create a network of computers connected to the main PC in the workshop. Through this software it is possible, for example, to view and analyze the deliveries, generate reports, print and export data in many file formats (xls, xlsx, csv, ods). A connection using a standard LAN cable or a Wi-Fi connection is required between the client PCs and the main PC.



P/N 39690

"iButton®" key allows operators to access the system. It is an alternative to PIN code.

P/N 39650 *

Low level gauge h 860 mm, suitable for 180-220 kg drums, to be connected with FCS.

P/N 39651 *

Low level gauge h 1300 mm, suitable for tanks, to be connected with FCS.

P/N 39652 *

Low level gauge h 1500 mm, suitable for tanks, to be connected with FCS.

P/N 39655

High level gauge for waste oil, suitable to be connected with FCS.

P/N 39657 *

Low level gauge h 860 mm, suitable for 180-220 kg drums, to be connected with FCS, with double contact.

P/N 39658 *

Low level gauge h 1300 mm, suitable for tanks, to be connected with FCS, with double contact.

P/N 39659 *

Low level gauge h 1500 mm, suitable for tanks, to be connected with FCS, with double contact.

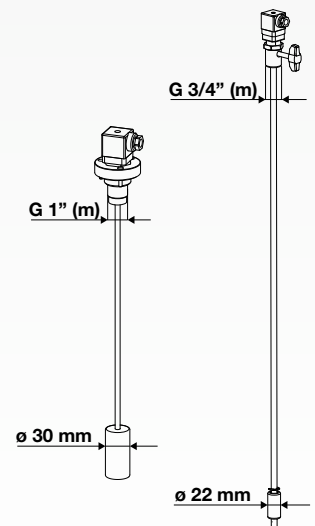
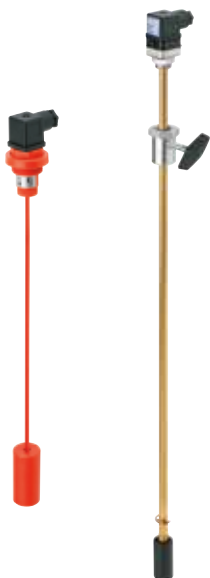

* not chemically compatible with AdBlue®



FCS COMPONENTS



P/N 39610 *

Pulser meter for oil with inlet/outlet G 1/2" (f) is used to measure fluids and to transmit data. It is usually installed on centralized system to control and manage delivery of fluids.



P/N 39611 *

Pulser meter for antifreeze and windshield washer fluid with inlet/outlet G 1/2" (f). It is used to measure fluids and to transmit data. It is usually installed on centralized system to control and manage delivery of fluids.



P/N 39613 *

Pulser meter for oil with inlet/outlet G 3/4" (f). It is used to measure fluids and to transmit data. It is usually installed on centralized system to control and manage delivery of fluids.



P/N 39614 *

Pulser meter for diesel with inlet/outlet G 3/4" (f). It is used to measure fluids and to transmit data. It is usually installed on centralized system to control and manage delivery of fluids.



P/N 39615 *

Pulser meter for oil with inlet/outlet G 1" (f). It is usually installed on centralized system to control and manage delivery of fluids.



P/N 39616 *

Pulser meter for diesel with inlet/outlet G 1" (f). It is usually installed on centralized system to control and manage delivery of fluids.



P/N 39609 *

AISI 304 stainless steel pulser for AdBlue® with inlet/outlet G 1/2" (f). Used for fluid measurement and remote data transmission. They are usually installed in fixed systems for fluid transfer/distribution where centralized control and management systems operate.



ACCESSORIES FOR FLUIDS ROOM



P/N 39280 *

Timer 24 V DC with daily and weekly programming for programmed activation of air solenoid valves 24 V DC connected with all the pneumatic pumps.



P/N 39281 *

Feeder 230 V AC - 24 V DC - 6 A. It provides power supply to all the accessories for the oil room.



P/N 39282 *

Automatic-manual selector 24 V DC for feeding solenoid valves, to activate every pump.



P/N 39284 *

The pneumatic solenoid valve 24 V DC with G 1/4" (f) x G 1/4" (f) connections, equipped with pressure regulator 0-8 bar, controls the opening and/or closing of the compressed air supply which feeds the pumps mounted on the fluid tanks. The connected DMU controls when it opens. Only one general pneumatic solenoid valve is recommended.

P/N 39285 *

The pneumatic solenoid valve 24 V DC with G 1/2" (f) x G 1/2" (f) connections, equipped with pressure regulator 0-8 bar, controls the opening and/or closing of the compressed air supply which feeds the pumps mounted on the fluid tanks.

The connected DMU controls when it opens. Only one general pneumatic solenoid valve is recommended.



P/N 39286 *

The pneumatic solenoid valve 24 V DC with G 1/4" (f) x G 1/4" (f) connections controls the opening and/or closing of the compressed air supply which feeds the pumps mounted on the fluid tanks. The connected DMU controls when it opens. Only one general pneumatic solenoid valve is recommended.

P/N 39287 *

The pneumatic solenoid valve 24 V DC with G 1/2" (f) x G 1/2" (f) connections controls the opening and/or closing of the compressed air supply for each single pump mounted on fluid tanks. The connected DMU controls when it opens. Only one general pneumatic solenoid valve is recommended.



P/N 39289 *

Luminous acoustic flashing light, connected with a level gauge, signals exhaustion of fluids.



P/N 39290 *

Electric line main stop push button for all the accessories in the oil room.



INSTALLATION EXAMPLES

EXAMPLE 1

FCS includes an Operator Control Unit (without printer for tickets and "iButton®") connected to DMU with 4 dispensers equipped with **Pulsar Single Valve**. The system is connected to a PC.

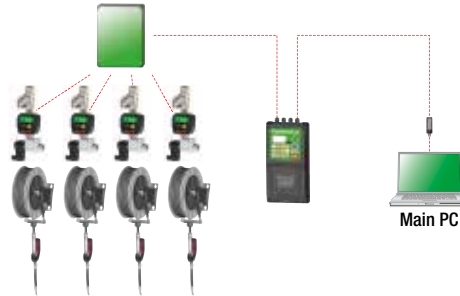

| SYSTEM CHARACTERISTICS | | |
|------------------------|-------------------|-----------|
| n° 1 | OCU Basic | P/N 39590 |
| n° 1 | DMU Basic | P/N 39595 |
| n° 4 | PSV + "Y" FILTER | P/N 39625 |
| n° 1 | Kit PC | P/N 39680 |
| n° 4 | Dispensing points | - |

EXAMPLE 2

FCS includes 2 Operator Control Units without "iButton®" but with printer for tickets. The first one is connected to 2 DMUs with 7 dispensers and remote display; the second one is connected to DMU with 4 dispensers.

Pulsar Single Valve are used only and the system is connected to a PC.

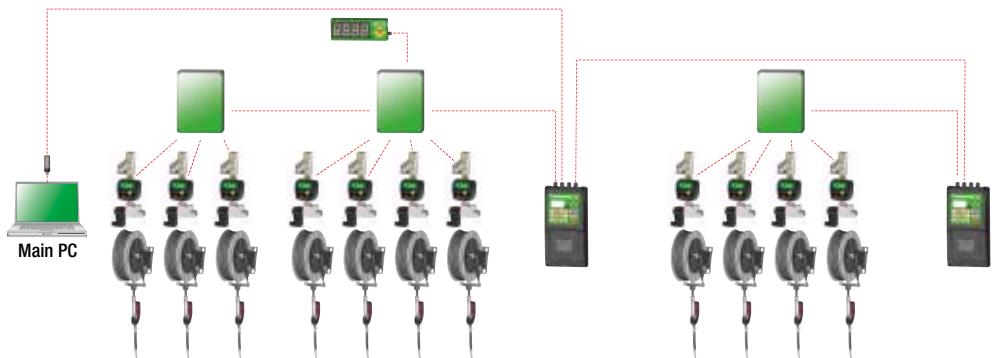

| SYSTEM CHARACTERISTICS | | |
|------------------------|-------------------------------|-----------|
| n° 2 | OCU Basic with ticket printer | P/N 39591 |
| n° 3 | DMU Basic | P/N 39595 |
| n° 11 | PSV + "Y" FILTER | P/N 39625 |

| SYSTEM CHARACTERISTICS | | |
|------------------------|-------------------|-----------|
| n° 1 | Display LCD | P/N 39640 |
| n° 1 | Kit PC | P/N 39680 |
| n° 11 | Dispensing points | - |

EXAMPLE 3

Full Optional version is equipped with all the available accessories. Every OCU is provided with "iButton®" and printer for tickets. There are **Pulsar Double Valves**, remote displays and 3 PCs connected each other through a network.

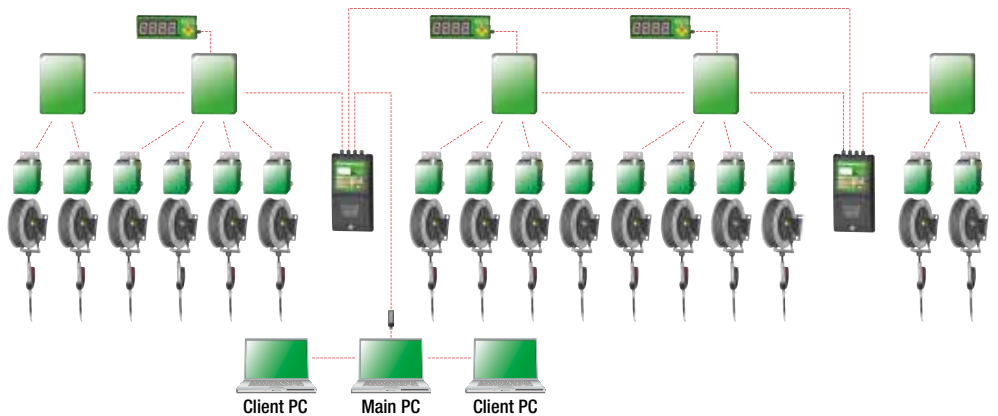

| SYSTEM CHARACTERISTICS | | |
|------------------------|---------------------------------------|-----------|
| n° 2 | OCU Full Optional with ticket printer | P/N 39599 |
| n° 5 | DMU Full Optional | P/N 39605 |
| n° 16 | PDV | P/N 39630 |

| SYSTEM CHARACTERISTICS | | |
|------------------------|-------------------|-----------|
| n° 3 | Display LCD | P/N 39640 |
| n° 1 | Kit PC | P/N 39680 |
| n° 1 | Software Network | P/N 39681 |
| n° 16 | Dispensing points | - |



ORIGINAL

spare parts

Always choose RAASM
original spare parts.

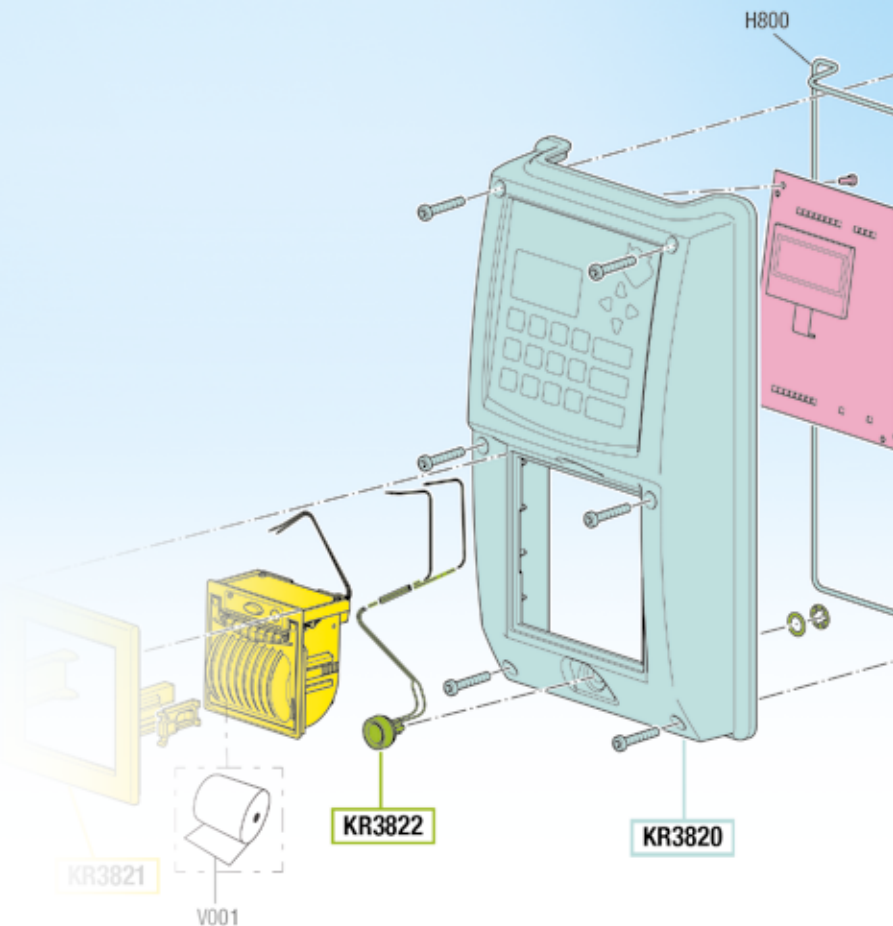

GENERAL SALES CONDITIONS

FOR FOREIGN MARKETS



The following general sales conditions regulate the sale of goods and services by the company RAASM S.p.A. for customers residing outside the territory of the Italian State.

Art. 1 GOODS DELIVERY TERMS

The goods are delivered ex works RAASM S.p.A. The subsequent transport/shipment must occur by, in the name and at the expense of the purchasing customer, even by means of a carrier appointed and designated by the same. All risks arising from loading, subsequent custody and transport are borne entirely by the purchasing customer.

Art. 2 MINIMUM ORDERS

Each order cannot be for less than € 1,500.00, net of fees, taxes, customs duties, discounts and rebates and any other charges not included in the price of the goods. If, at the option of RAASM S.p.A., orders for lower amounts are accepted, an extra charge of € 155,00 shall be applied for order management administrative expenses.

Art. 3 ACCESSORIES

All the accessories given in the price list (plugs, oil bar taps, oil guns, grease guns, probes, protection caps, clutches, swivelling supports, etc.) are supplied exclusively for fitting to or combining with the items RAASM S.p.A. produces

Art. 4 COMPLAINTS

Any defects immediately noticed after a brief inspection of the goods (damage, shortages or different product from that ordered) must be notified in writing to our company within 8 (eight) days of receipt the goods. Any defects in the product noticeable only during its use must be notified in writing to RAASM S.p.A. within 8 (eight) days of being detected. Any returns of goods must be authorized in advance by RAASM S.p.A. and freight charges are at the customer's expenses.

Art. 5 DELIVERY TIMES/TERMS

Delivery times and dates are only approximate and are subject to change. Any delays in delivery do not entitle the customer to cancel the order or claim compensation for damages caused by delay of delivery. Delivery times for urgent orders must be agreed directly with RAASM S.p.A. RAASM S.p.A. has the right not to carry out the order and/or totally or partially carry it out, without this giving rise to reimbursement or claims for compensation for damage.

Art. 6 PACKS AND PACKAGING

Packaging costs are included in the price, except for special packing, which shall be charged at cost.

Art. 7 PRICES

The current Price list cancels and replaces the previous price list. In the event of changes to our price list and/or individual items, the goods shall be forwarded at the price in force on the day of the order confirmation. The price list and/or the prices of individual items can be changed even without notice, according to the changes in market conditions or technical innovations/modifications made to the product. The prices are understood to be ex works RAASM S.p.A.

Art. 8 PAYMENTS

Payments must be made exclusively to RAASM S.p.A. at the agreed conditions. Under no circumstances will deductions or roundings be accepted. In case of late payment with respect to the agreed conditions, RAASM S.p.A. reserves the right to charge interest at the current rate, effective from the day after that agreed for payment, plus any additional expenses. Discounts conditional on the payment term and already credited shall be recharged.

Art. 9 WARRANTY

RAASM S.p.A. provides each product with the communication of particular instructions for the installation, use and maintenance requirements and the need to carry out possible checks on the product. All the technical information and data mentioned in the catalogue and in the price-list in force are not binding and can be changed without prior notice for the purpose of improving the quality of the products. All products manufactured by RAASM S.p.A. are guaranteed for a period of 5 (five) years from the date of delivery to the first user. The user must keep and show the sales invoice - or an equivalent document - together with the item's serial number in order to make a claim under the RAASM S.p.A. guarantee. The 5 (five) year guarantee does not apply to components which are subject to normal wear and tear (such as gaskets, diaphragms, O-rings, hoses, etc.), electronic components and items that are sold but not manufactured by RAASM S.p.A. (marked with a red asterisk in the current product catalogue) which are guaranteed for 1 (one) year from the date of delivery to the first user.

1 (one) year warranty is valid also for the following products:

- digital litre counters and FCS system;

- cable reels;

- electric, pneumatic or hydraulic motor supplied with our industrial hose reels s. 600 and 700.

Incorrect installation, use or maintenance of the product shall void the warranty. Upon written notice, the articles must be returned free to our Factory for checking and acceptance. In any case, the guarantee expires in the 10th year from the date of manufacture (indicated by the serial number), if the stated expiry takes place before the expiration terms indicated above (1 or 5 years from delivery to the first user).

The manufacturer declines any responsibility for possible inaccuracies contained in this catalogue, due to printing or transcription errors. The manufacturer reserves the right to make any changes or improvements of a functional, technical or aesthetic nature without prior notice.

RAASM

Art. 10 RESPONSIBILITY

RAASM S.p.A. is exempt from any responsibility and liability for accidents that may occur to persons and property, as a result of or during the use of the equipment, due to or depending on the same whenever the products have been damaged during transport, tampered with or modified, or improperly used, or stored, installed, protected and preserved without complying with the instructions of RAASM S.p.A. as given in the installation, use and maintenance instruction manuals for each product. RAASM S.p.A. is liable for the value for the supplied product and cannot be held responsible in any way for other possible costs or additional costs that the customer may bear.

Art. 11 CONFIDENTIALITY

Information not in the public domain that is exchanged in the execution of the contract is subject to the obligation of confidentiality, secrecy and security; said information is covered as an industrial secret and is of a confidential and reserved nature and may not be disseminated to third parties; its use is permitted exclusively and strictly to execute the supply contract.

Art. 12 INTELLECTUAL PROPERTY RIGHTS

The RAASM trademark, and likewise the name RAASM, RAASM S.p.A., the logo and the other distinctive signs are internationally registered trademarks, and RAASM S.p.A. does not authorise their use and application under any circumstances. Without prior written consent from RAASM S.p.A., the content of catalogues, price lists, instruction manuals and similar, including content on the website may not be reproduced, either entirely or partially, nor may it be transferred by electronic or traditional means, nor may it be modified or utilised by any means and for any purpose. All rights are held by RAASM S.p.A. The customer acknowledges that RAASM S.p.A. holds exclusive ownership of all the parts, images, photographs and signs not in common usage, the content in the catalogues, price lists, instruction manuals and similar and/or present on the website www.raasm.com and/or other channels and/or social networks used by RAASM S.p.A. for their informational and marketing campaigns pursuant to Copyright Law and the Industrial Property Code.

Art. 13 INFORMATION ON THE PROCESSING OF DATA PURSUANT TO ITALIAN LEGISLATIVE DECREE 196/2003

In accordance with article 13 of Italian Legislative Decree 196/2003 - Personal Data Protection Code - you are hereby advised that the processing of the personal data, provided with the purchase of goods or services and/or the supply of goods or services is solely for the purposes of carrying out the contract-based obligations and to comply with the specific requests from customers/ suppliers, as well as adhering to legislative obligations, in particular accounting and tax obligations or to respect orders issued by public authorities or to exercise a right in court. The data shall also be used for commercial statistics for corporate use and to obtain commercial information on our products and services if expressly authorised by the applicant. The processing of data shall be done using hard-copy and computerised procedures, in the manner and within the limits necessary to achieve the aforementioned purposes. Data may be communicated and processed by other companies in the Group for the same specified purposes, and may be made known to employees of our company, consultants and other suppliers, always and exclusively within the limits of the aforementioned purposes. The provision of data is mandatory for the correct execution of the contract and pre-contract based obligations, and failure to do so could result in it being impossible to fully comply with contractual obligations, and make it impossible to provide updates on the new products and services offered by our company. Data shall be processed for the duration of the contract relationship in place and subsequently to fulfil any legal formalities.

Art. 14 RIGHTS OF DATA SUBJECTS

The information is aimed at defining the limits and methods for the processing of data, based on which individual customers and/or suppliers may freely authorise the collection and subsequent use of data. Data subjects are entitled to the rights pursuant to article 7 of the aforementioned Code and in particular, the right to access their personal data, ask for the amendment, update and cancellation thereof, if incomplete, incorrect or collected in violation of the law, and may object to the processing for legitimate reasons, addressing requests in this regard to RAASM S.p.A. Pursuant to the same article the data subject also has the right to request the complete and updated list of the Data Supervisors, and to ask for the cancellation, transformation into anonymous form or blocking of data processed in violation of the law, and to oppose in any case, for legitimate reasons, the processing thereof.

To exercise these rights, and in the case of problems or any requests for clarification regarding what has been explained herein, kindly address these to RAASM S.p.A. - Via Marangoni, 33, Cassola (VI) - Italy or to the following email address: info@raasm.com.

Art. 15 DATA CONTROLLER

The Data Controller is RAASM S.p.A. with registered office at Via Marangoni 33, Cassola (VI) – Italy, and this is where the data processing shall take place.

Art. 16 COMPETENT LAW COURT

Any disputes shall be settled by the Law Court of Vicenza, Italy.

The company RAASM S.p.A. holds the exclusive Intellectual Property rights on the RAASM trademark and all rights to its use and reproduction are reserved. The RAASM trademark is a registered trademark and is protected at an international level. No part of the RAASM trademark and its logo may be utilized, copied and/or used in any form, time and space, even by means of improper alterations.

The Intellectual Property rights on the images published in this catalogue are owned exclusively by RAASM S.p.A. and any unauthorized reproduction is prohibited.

Any use in general of the assets protected by the Intellectual Property rights of RAASM S.p.A. is prohibited and is subject to the prior written permission of RAASM S.p.A.





Company with quality,
environment and safety system
according to ISO 9001:2015,
ISO 14001:2015 and
ISO 45001:2018 standards

RAASM S.p.A.
36022 S. ZENO DI CASSOLA (VI)
Via Marangoni, 33 - ITALY

Export department
Tel. +39 0424 571130 - Fax +39 0424 571135

Technical department
Tel. +39 0424 571150 - Fax +39 0424 571155
info@raasm.com - www.raasm.com



GB WRC226FCS-GB
rev. 00

Authorized dealer