



P/N 246564.200

Manual trolley-mounted hose reel in AISI 304 stainless steel s. 560, for hot water, 100 bar, without hose. Inlet-outlet G 1" (f). Hose guide, safety system and rotation lock as standard

AREAS OF USE

Agriculture, Cleaning, Chemical industry,
Manufacturing industry, Mining industry, Shipping and
offshore, Railway transport

FEATURES

Pressure	100 bar
Compatible fluids	water max 130 °C
Swivel joint	AISI 304 stainless steel
Seals	Viton®
Characteristic	trolley-mounted
Material	AISI 304 stainless steel
Couplings	-
Hose	-
Ø and hose length	-
Inlet	G 1" (f)
Outlet	G 1" (f)
Reel flow path	AISI 304 stainless steel



OVERALL DIMENSIONS (mm)

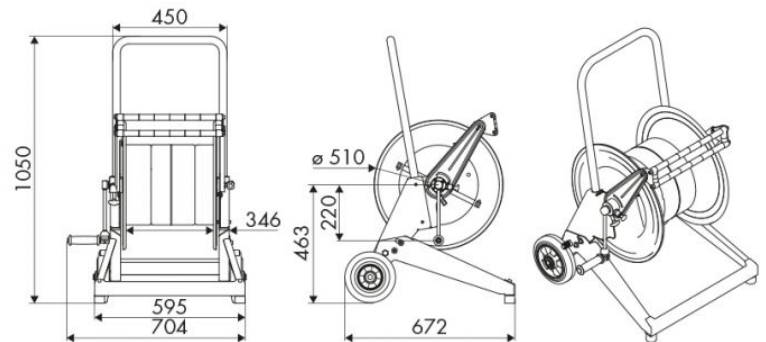

HOSE REELS CAPACITY

Ø 1/4"	Ø 5/16"	Ø 3/8"	Ø 1/2"	Ø 5/8"	Ø 3/4"	Ø 1"
320 m	240 m	140 m	100 m	90 m	60 m	30 m