



ADVANCED FLUID
MANAGEMENT SOLUTIONS

RAASM S.p.a.

Via Marangoni 33, 36022
S. Zeno di Cassola (VI) Italy
Tel. +39 0424 570891
info@raasm.com

P/N 246534.300

Manual trolley-mounted hose reel in AISI 304 stainless steel s. 530, for hot water, 200 bar, without hose. Inlet G 3/8" (f), outlet G 1/2" (f). Hose guide, safety system and rotation lock as standard

AREAS OF USE

Agriculture, Cleaning, Chemical industry,
Manufacturing industry, Mining industry, Shipping and
offshore, Railway transport

FEATURES

Pressure	200 bar
Compatible fluids	water max 130 °C
Swivel joint	AISI 304 stainless steel
Seals	Viton®
Characteristic	trolley-mounted
Material	AISI 304 stainless steel
Couplings	-
Hose	-
Ø and hose length	-
Inlet	G 3/8" (f)
Outlet	G 1/2" (f)
Reel flow path	AISI 304 stainless steel



OVERALL DIMENSIONS (mm)

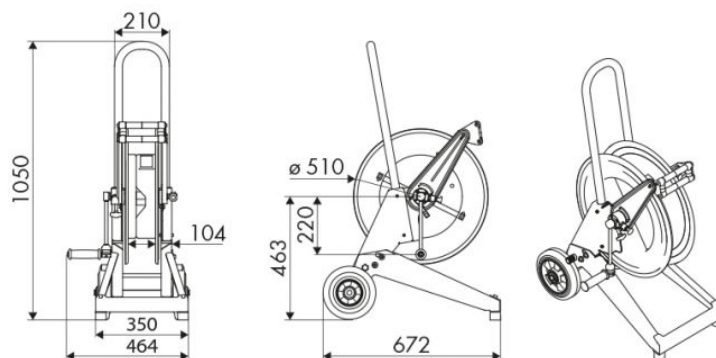

HOSE REELS CAPACITY

Ø 1/4"	Ø 5/16"	Ø 3/8"	Ø 1/2"
90 m	65 m	35 m	25 m