



ADVANCED FLUID  
MANAGEMENT SOLUTIONS

**RAASM S.p.a.**

Via Marangoni 33, 36022  
S. Zeno di Cassola (VI) Italy  
Tel. +39 0424 570891  
info@raasm.com

## P/N 8540.350



Fixed hose reel s. 540, for hot water, 400 bar, without hose. Inlet G 3/8" (f) - outlet G 1/2" (f)

### AREAS OF USE

Aeronautics, Agriculture, Automotive, Building and road construction, Manufacturing industry, Mining industry, Lube trucks and transports, Railway transport

### FEATURES

Pressure	400 bar
Compatible fluids	water max 130 °C
Swivel joint	AISI 304 stainless steel
Seals	Viton® and Teflon®
Characteristic	fixed
Material	painted steel
Couplings	-
Hose	-
∅ and hose length	-
Inlet	G 3/8" (f)
Outlet	G 1/2" (f)
Reel flow path	AISI 304 stainless steel - zinc plated steel



### OVERALL DIMENSIONS (mm)

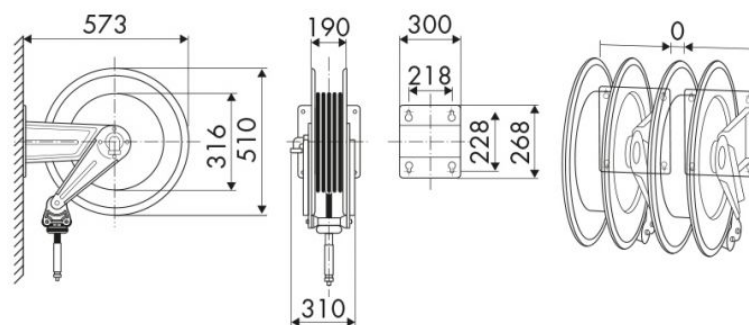

### HOSE REELS CAPACITY

∅ 3/8"	∅ 1/2"
30 m	30 m