



ADVANCED FLUID
MANAGEMENT SOLUTIONS

RAASM S.p.a.

Via Marangoni 33, 36022
S. Zeno di Cassola (VI) Italy
Tel. +39 0424 570891
info@raasm.com

P/N 8530.5500



Fixed hose reel s. 530, for hot water, 400 bar, without hose. Arrangement for double inlet-outlet. Inlet G 3/8" (f), outlet G 3/8" (m)

AREAS OF USE

Cleaning, Manufacturing industry, Shipping and offshore

FEATURES

Pressure	700 bar
Compatible fluids	water max 130 °C
Swivel joint	AISI 304 stainless steel
Seals	Teflon®
Characteristic	fixed
Material	painted steel
Couplings	-
Hose	-
∅ and hose length	-
Inlet	G 3/8" (f)
Outlet	G 3/8" (m)
Reel flow path	AISI 304 stainless steel - zinc plated steel



OVERALL DIMENSIONS (mm)

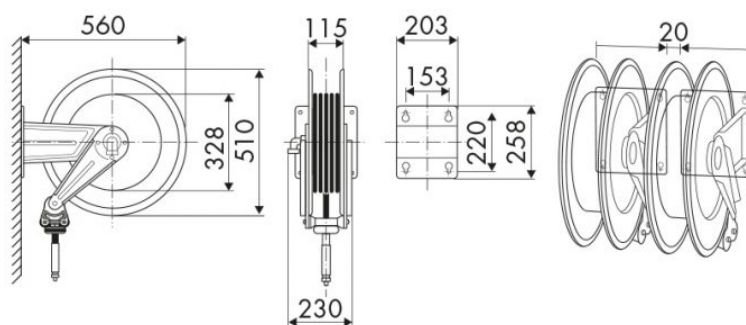

HOSE REELS CAPACITY

∅ 5/16"	∅ 3/8"
20 m	15 m