



ADVANCED FLUID
MANAGEMENT SOLUTIONS

RAASM S.p.a.

Via Marangoni 33, 36022
S. Zeno di Cassola (VI) Italy
Tel. +39 0424 570891
info@raasm.com

P/N 8530.3000



Fixed hose reel s. 530, for oil and water, 200 bar, without hose. Arrangement for double inlet-outlet. Inlet-outlet G 3/8" (m)

AREAS OF USE

Cleaning, Manufacturing industry, Shipping and offshore

FEATURES

Pressure	200 bar
Compatible fluids	oils - water
Swivel joint	2 AISI 304 stainless steel swivels joint
Seals	Viton®
Characteristic	fixed
Material	painted steel
Couplings	-
Hose	-
Ø and hose length	-
Inlet	G 3/8" (f)
Outlet	G 3/8" (m)
Reel flow path	AISI 304 stainless steel - zinc plated steel



OVERALL DIMENSIONS (mm)

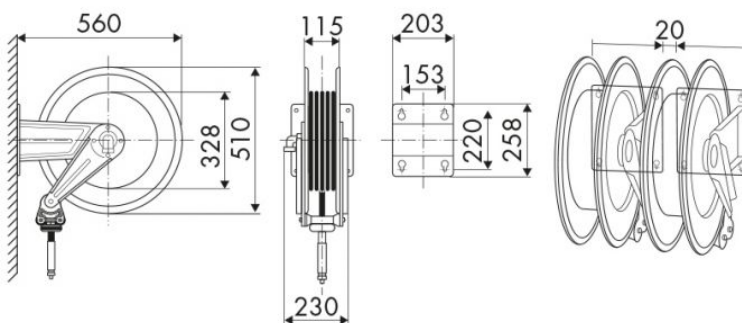

HOSE REELS CAPACITY

Ø 1/4"	Ø 5/16"	Ø 3/8"
22 m	20 m	15 m