



ADVANCED FLUID
MANAGEMENT SOLUTIONS

RAASM S.p.a.

Via Marangoni 33, 36022
S. Zeno di Cassola (VI) Italy
Tel. +39 0424 570891
info@raasm.com

P/N 8530.1000



Fixed hose reel s. 530, for air-water, 20 bar, without hose. Arrangement for double inlet-outlet. Inlet G 1/2" (f), outlet G 3/8" (m)

AREAS OF USE

Cleaning, Manufacturing industry, Shipping and offshore

FEATURES

Pressure	20 bar
Compatible fluids	air - water
Swivel joint	2 brass swivels joint
Seals	Viton®
Characteristic	fixed
Material	painted steel
Couplings	-
Hose	-
∅ and hose length	-
Inlet	G 1/2" (f)
Outlet	G 3/4" (m)
Reel flow path	brass - zinc plated steel



OVERALL DIMENSIONS (mm)

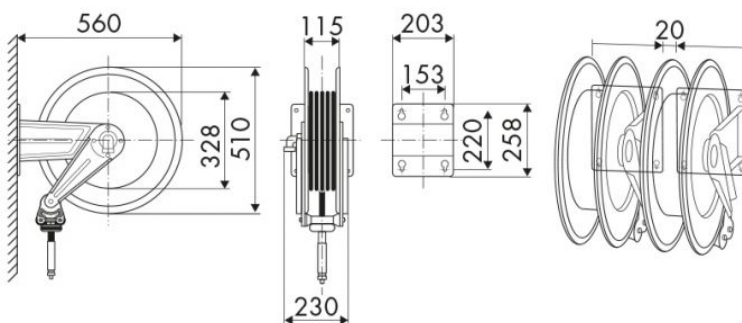

HOSE REELS CAPACITY

∅ 1/4"	∅ 5/16"	∅ 3/8"
22 m	20 m	15 m