



ADVANCED FLUID  
MANAGEMENT SOLUTIONS

**RAASM S.p.a.**

Via Marangoni 33, 36022  
S. Zeno di Cassola (VI) Italy  
Tel. +39 0424 570891  
info@raasm.com

## P/N 8390.800



Fixed hose reel s. 390, for Lpg-Nat. Gas, 20 bar, without hose. Inlet-outlet G 3/8" (m)

### AREAS OF USE

Building and road construction, Manufacturing industry, Mining industry, Shipping and offshore

### FEATURES

|                   |                           |
|-------------------|---------------------------|
| Pressure          | 20 bar                    |
| Compatible fluids | LPG/methane               |
| Swivel joint      | brass                     |
| Seals             | Viton®                    |
| Characteristic    | fixed                     |
| Material          | painted steel             |
| Couplings         | -                         |
| Hose              | -                         |
| ∅ and hose length | -                         |
| Inlet             | G 3/8" (m) LH             |
| Outlet            | G 3/8" (m) LH             |
| Reel flow path    | brass - zinc plated steel |

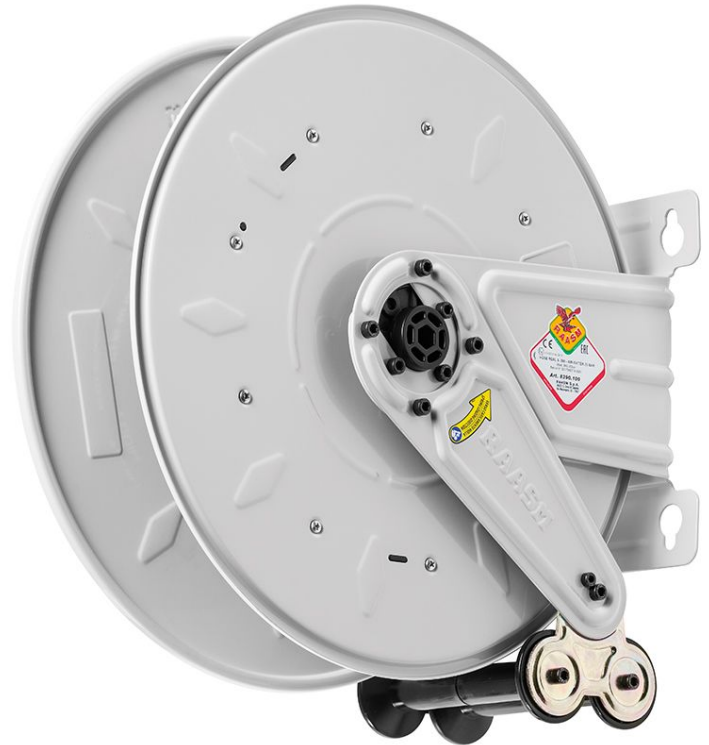

### OVERALL DIMENSIONS (mm)

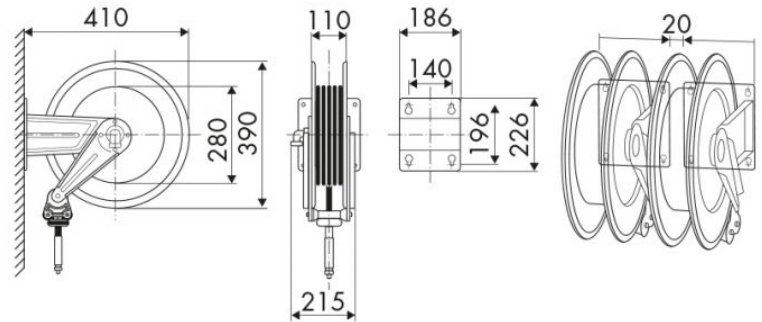

### HOSE REELS CAPACITY

| ∅ 1/4" | ∅ 5/16" | ∅ 3/8" | ∅ 1/2" |
|--------|---------|--------|--------|
| 20 m   | 20 m    | 18 m   | 15 m   |