



ADVANCED FLUID
MANAGEMENT SOLUTIONS

RAASM S.p.a.

Via Marangoni 33, 36022
S. Zeno di Cassola (VI) Italy
Tel. +39 0424 570891
info@raasm.com

P/N 8378.100



Fixed hose reel s. 390, for air-water, 20 bar, without hose. Inlet-outlet G 3/8"(m)

AREAS OF USE

Aeronautics, Agriculture, Automotive, Building and road construction, Manufacturing industry, Lube trucks and transports

FEATURES

Pressure	20 bar
Compatible fluids	air - water
Swivel joint	brass
Seals	Viton®
Characteristic	fixed
Material	painted steel
Couplings	-
Hose	-
∅ and hose length	-
Inlet	G 3/8" (m)
Outlet	G 3/8" (f)
Reel flow path	brass - nylon PA6



OVERALL DIMENSIONS (mm)

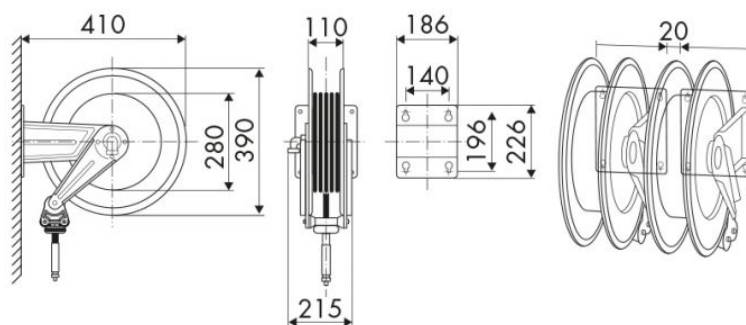

HOSE REELS CAPACITY

∅ 8 x 12	∅ 10 x 14,5	∅ 13 x 19
18 m	16 m	12 m