



ADVANCED FLUID  
MANAGEMENT SOLUTIONS

**RAASM S.p.a.**

Via Marangoni 33, 36022

S. Zeno di Cassola (VI) Italy

Tel. +39 0424 570891

info@raasm.com

## P/N 8618.200

Motorized hose reel s. 618, for hot water, 100 bar, without hose. Inlet-outlet G 1" (f)

### AREAS OF USE

Manufacturing industry, Mining industry, Shipping and offshore, Railway transport

### FEATURES

Pressure	100 bar
Compatible fluids	water max 130 °C
Swivel joint	AISI 304 stainless steel
Seals	Viton®
Characteristic	pneumatic
Material	painted steel
Couplings	-
Hose	-
∅ and hose length	-
Inlet	G 1" (f)
Outlet	G 1" (f)
Reel flow path	AISI 304 stainless steel - zinc plated steel



### OVERALL DIMENSIONS (mm)

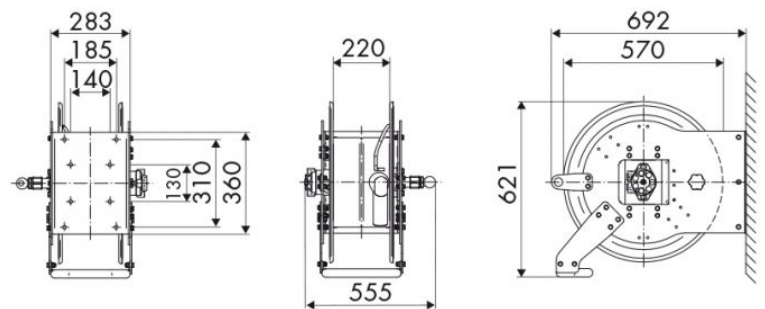

### HOSE REELS CAPACITY

∅ 3/8"	∅ 1/2"	∅ 5/8"	∅ 3/4"	∅ 1"
90 m	65 m	45 m	30 m	20 m