



P/N 7841001.4000



Manual hose reel s. 700, for oil and similar, 70 bar, without hose. Drum width 410 mm. Inlet-outlet G 2" (f)

AREAS OF USE

Manufacturing industry, Mining industry, Shipping and offshore, Railway transport

FEATURES

Pressure	70 bar
Compatible fluids	oils and similar products
Swivel joint	zinc plated steel
Seals	Viton®
Characteristic	manual
Material	painted steel
Couplings	-
Hose	-
∅ and hose length	-
Inlet	G 2" (f)
Outlet	G 2" (f)
Reel flow path	zinc plated steel

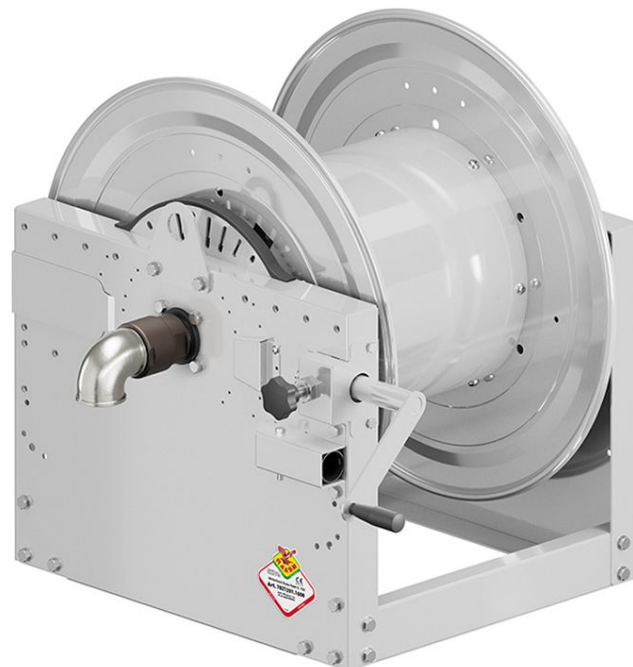

OVERALL DIMENSIONS (mm)

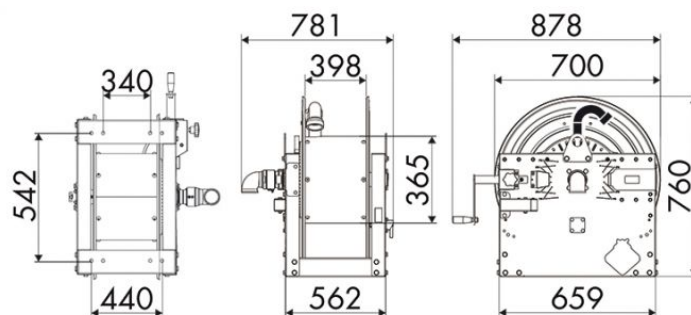

HOSE REELS CAPACITY

∅ 3/8"	∅ 1/2"	∅ 3/4"	∅ 1"	∅ 1,1/4"	∅ 1,1/2"	∅ 2"
290 m	180 m	120 m	60 m	35 m	30 m	20 m