



ADVANCED FLUID
MANAGEMENT SOLUTIONS

RAASM S.p.a.

Via Marangoni 33, 36022
S. Zeno di Cassola (VI) Italy
Tel. +39 0424 570891
info@raasm.com

P/N 75400.100

Manual hose reel s. 540, for air-water, 20 bar, without hose. Inlet-outlet G 1" (f)

AREAS OF USE

Agriculture, Building and road construction, Manufacturing industry, Mining industry, Lube trucks and transports, Shipping and offshore

FEATURES

Pressure	10 - 20 bar
Compatible fluids	air - water - diesel fuel
Swivel joint	brass
Seals	Viton®
Characteristic	fixed
Material	painted steel
Couplings	-
Hose	-
∅ and hose length	-
Inlet	G 1" (f)
Outlet	G 1" (f)
Reel flow path	brass - zinc plated steel



OVERALL DIMENSIONS (mm)

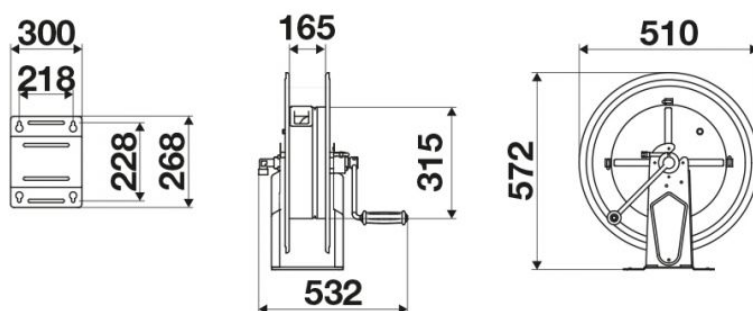

HOSE REELS CAPACITY

∅ 1/4"	∅ 5/16"	∅ 3/8"	∅ 1/2"	∅ 5/8"	∅ 3/4"	∅ 1"
150 m	110 m	65 m	45 m	35 m	25 m	15 m