



P/N 7824001.4000



Manual hose reel in AISI 304 stainless steel s. 700, for water, oil, diesel and industrial fluids, 70 bar, without hose. Drum width 270 mm. Inlet-outlet G 2" (f)

AREAS OF USE

Manufacturing industry, Mining industry, Shipping and offshore, Railway transport

FEATURES

Pressure	70 bar
Compatible fluids	water - oils - diesel fuel - industrial fluid
Swivel joint	AISI 304 stainless steel
Seals	Viton®
Characteristic	manual
Material	AISI 304 stainless steel
Couplings	-
Hose	-
∅ and hose length	-
Inlet	G 2" (f)
Outlet	G 2" (f)
Reel flow path	AISI 304 stainless steel



OVERALL DIMENSIONS (mm)

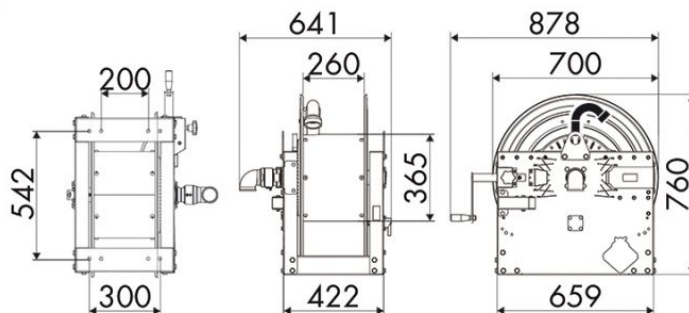

HOSE REELS CAPACITY

∅ 3/8"	∅ 1/2"	∅ 3/4"	∅ 1"	∅ 1,1/4"	∅ 1,1/2"	∅ 2"
160 m	110 m	65 m	30 m	20 m	15 m	10 m