



ADVANCED FLUID  
MANAGEMENT SOLUTIONS

**RAASM S.p.a.**

Via Marangoni 33, 36022  
S. Zeno di Cassola (VI) Italy  
Tel. +39 0424 570891  
info@raasm.com

## P/N 75320.500

Manual hose reel in AISI 304 stainless steel s. 530, for grease, 600 bar, without hose. Inlet G 3/8" (f), outlet G 1/2" (f)

### AREAS OF USE

Agriculture, Cleaning, Chemical industry,  
Manufacturing industry, Mining industry, Shipping and  
offshore, Railway transport

### FEATURES

Pressure	600 bar
Compatible fluids	grease
Swivel joint	zinc plated steel
Seals	polyurethane
Characteristic	fixed
Material	AISI 304 stainless steel
Couplings	-
Hose	-
Ø and hose length	-
Inlet	G 3/8" (f)
Outlet	G 1/2" (f)
Reel flow path	zinc plated steel - AISI 304 stainless steel



### OVERALL DIMENSIONS (mm)

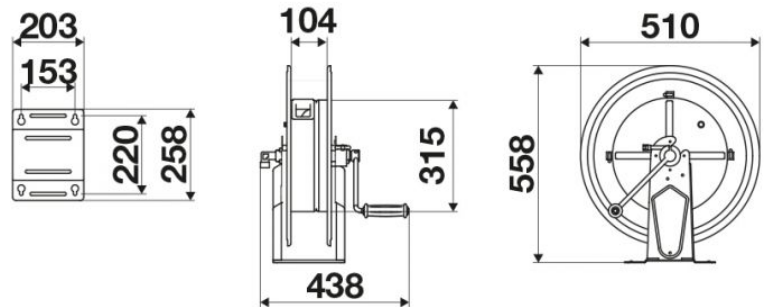

### HOSE REELS CAPACITY

Ø 1/4"	Ø 5/16"	Ø 3/8"	Ø 1/2"	Ø 5/8"
90 m	65 m	35 m	25 m	20 m