



ADVANCED FLUID
MANAGEMENT SOLUTIONS

RAASM S.p.a.

Via Marangoni 33, 36022
S. Zeno di Cassola (VI) Italy
Tel. +39 0424 570891
info@raasm.com

P/N 74320.500

Manual hose reel in AISI 304 stainless steel s. 430, for grease, 600 bar, without hose. Inlet G 3/8" (f), outlet G 1/2" (f)

AREAS OF USE

Agriculture, Cleaning, Chemical industry,
Manufacturing industry, Mining industry, Shipping and
offshore, Railway transport

FEATURES

Pressure	600 bar
Compatible fluids	grease
Swivel joint	zinc plated steel
Seals	polyurethane
Characteristic	fixed
Material	AISI 304 stainless steel
Couplings	-
Hose	-
Ø and hose length	-
Inlet	G 3/8" (f)
Outlet	G 1/2" (f)
Reel flow path	zinc plated steel - AISI 304 stainless steel



OVERALL DIMENSIONS (mm)

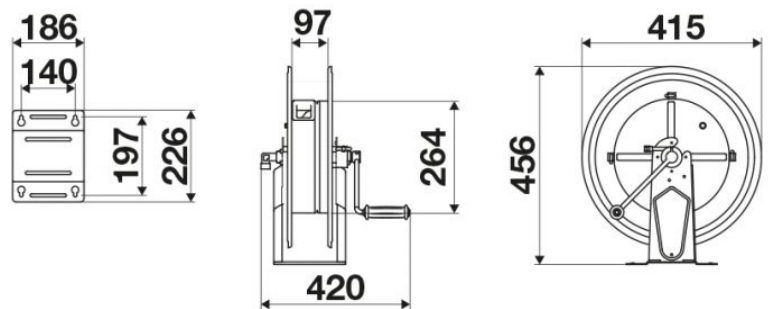

HOSE REELS CAPACITY

Ø 1/4"	Ø 5/16"	Ø 3/8"	Ø 1/2"	Ø 5/8"
50 m	35 m	25 m	17 m	15 m