



ADVANCED FLUID  
MANAGEMENT SOLUTIONS

**RAASM S.p.a.**

Via Marangoni 33, 36022  
S. Zeno di Cassola (VI) Italy  
Tel. +39 0424 570891  
info@raasm.com

## P/N 3C3/5066VNHH

Diaphragm pump in aluminum with cataphoresis treatment series AAB-2 with multi ported inlet/outlet, membranes in NBR, balls and seats in Hytrel®

### AREAS OF USE

Aeronautics, Agriculture, Automotive, Building and road construction, Chemical industry, Manufacturing industry, Mining industry, Lube trucks and transports, Shipping and offshore, Railway transport

### FEATURES

Flow rate	610 l/min
Ratio	1:1
Max pressure	8 bar
Max cycles for minute	147 cpm
Delivery for cycles	4,150 l
Max suction lift	dry column 5 m - wet column 7,5 m
Max size pumpable solids	6,5 mm
Max working temperature	100 °C
Noise level	82 dB
Max air consumption	4,00 m <sup>3</sup> /min
Air working pressure	2 ÷ 6 bar
Air inlet connection	G 3/4" (f)
Air outlet connection (muffler)	G 1" (f)
Fluid inlet connection	G 2.1/2" (f)
Fluid outlet connection	G 2" (f)
Balls for inlet	ball valve
Membranes	NBR



### OVERALL DIMENSIONS (mm)

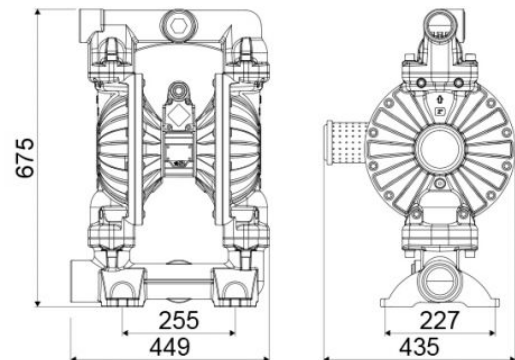

Balls	Hytrel®
Seats	Hytrel®
Packing	No. 1 - 0,12 m <sup>3</sup>
Gross weight	45 kg